

COMPRESSOR (SINGLE CYLINDER)



PARAMETER
Working Volume: 229cm³
Air Cooling, Max Speed: 2800 RPM
Stroke 36mm

SORL P/N
RL3509AA

Application
DAF 1517931
MERCEDES 0011315201

Repair Kit 3509 001 001 9



Cylinder Liner 3509 001 002 1
Cross Ref.: Wabco: 411 034 570 4
Mercedes: 000 131 36 0



Cylinder Head 3509 001 001 1
Cross Ref.: WABCO: 411 035 652 2
Mercedes: 000 131 21 15



Valve Plate 3509 001 002 8
Cross Ref.: Mercedes: 000 130 20 20



Bearing Flange 3509 001 006 1
Cross Ref.: WABCO: 411 042 660 4
Mercedes: 000 131 11 32



Crankshaft 3509 001 005 1
Cross Ref.: WABCO: 411 042 690 4
Mercedes: 000 131 37 16



Connecting Rod 3509 001 001 8



Valve Plate Kit 3509 010 014 9
Cross Ref.: WABCO: 411 034 500 2
Mercedes: 000 131 13 20



Cylinder Liner with Piston & Rings 3509 001 017 9
Cross Ref.: Mercedes: 000 130 0208



Piston And Rings 3509 001 003 8
Cross Ref.: WABCO: 411 042 620 2
Mercedes: 000 130 11 17



Piston 3509 001 005 8



Rings 3509 001 007 8



COMPRESSOR (SINGLE CYLINDER)



PARAMETER
Working Volume: 115cm³
Air Cooling, Max Speed: 2800 RPM
Stroke 26mm

SORL P/N
RL3509AD

Cross Ref.
LK1314

Application
Iveco 1261822
1261731

Repair Kit 3509 004 001 9
Mercedes: 000 130 99 80

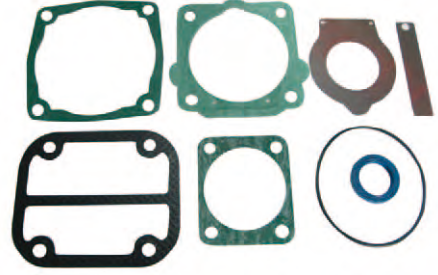

Cylinder Head 3509 004 001 1
Mercedes: 000 131 27 19



Valve Plate 3509 004 002 8
Cross Ref.: VOLVO: 1309555



Crankshaft 3509 004 008 1
Cross Ref.: Mercedes: 000 131 42 16



Connecting Rod 3509 004 005 1
Cross Ref.: VOLVO: 1698852
Mercedes: 000 131 18 17



Cylinder Liner 3509 004 002 1
Cross Ref.: Mercedes: 000 131 34 02



Piston And Rings 3509 004 003 8
Cross Ref.: Mercedes: 000 131 16 07



Piston 3509 004 001 8



Rings 3509 004 008 8
Cross Ref.: Mercedes: 000 131 67 11

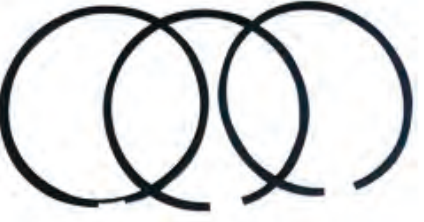

COMPRESSOR (SINGLE CYLINDER)



PARAMETER
Working Volume: 154cm³
Air Cooling, Max Speed: 3000 RPM
Stroke 35mm

SORL P/N
RL3509AD-A

Cross Ref.
I88770R

Application
Mercedes A0031314801

Repair Kit 3509 004 002 9



Cylinder Head 3509 004 004 9



Valve Plate Kit 3509 004 005 9
Cross Ref.: Mercedes: 000 130 49 20



Crankshaft 3509 004 023 1
Cross Ref.: Mercedes: 000 130 20 20



Connecting Rod 3509 004 005 1
Cross Ref.: VOLVO: 1698852
Mercedes: 000 131 18 17



Valve Plate 3509 004 002 8
Cross Ref.: VOLVO: 1309555



Repair Kit 3509 004 006 9

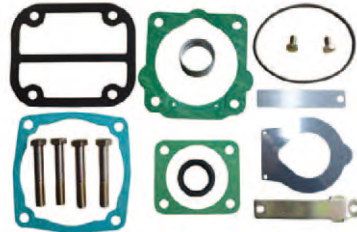

Cylinder Head With Plate Kit 3509 004 009 9



Rings 3509 004 021 8

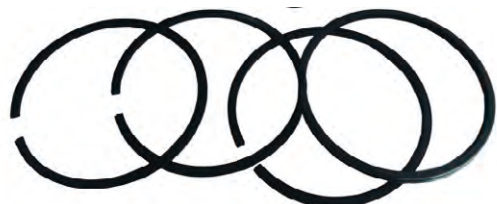

Cylinder Liner 3509 004 002 1
Cross Ref.: Mercedes: 000 131 34 02



Cylinder Liner with Piston & Rings 3509 004 008 9



Piston And Rings 3509 004 007 9



Piston 3509 004 020 8



COMPRESSOR (SINGLE CYLINDER)



PARAMETER
Working Volume: 225cm³
Water Cooling, Max Speed: 3000 RPM
Stroke 37mm

SORL P/N
RL3509CC

Cross Ref.
I136928R, 4111510060

Application
Mercedes A3761310101
A3761317401

Repair Kit 3509 005 002 9



Cylinder Head With Plate K 3509 005 003 9



Connecting Rod 3509 004 005 1

Cross Ref.: VOLVO: 1698852
Mercedes: 000 131 18 17



Bearing Flange 3509 004 025 1



Valve Plate Kit 3509 005 004 9



Repair Kit 3509 005 006 9

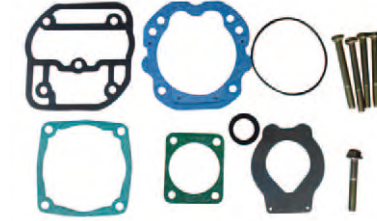

Crankshaft 3509 005 025 1



Repair Kit 3509 005 014 9



Rings 3509 005 004 8

Cross Ref.: Mercedes: 001 131 06 11



Repair Kit 3509 005 015 9



Cylinder Liner with Piston & Rings 3509 005 009 9



Piston And Rings 3509 005 005 9

Cross Ref.: Scania:1698848
Mercedes: 001 131 93 11



Piston 3509 005 003 8



COMPRESSOR (SINGLE CYLINDER)



PARAMETER
Working Volume: 225cm³
Water Cooling, Max Speed: 3000 RPM
Stroke 37mm

SORL P/N
RL3509AN-A

Cross Ref.
K001330

Application
VW 2R0100759H
VOLVO 20742000

Repair Kit 3509 014 001 9

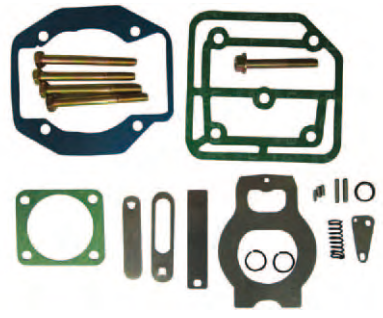

Cylinder Head 3509 014 006 1



Valve Plate Kit 3509 014 004 9



Connecting Rod 3509 004 005 1

Cross Ref.: VOLVO: 1698852
Mercedes: 000 131 18 17



Valve Kit 3509 014 006 9



unloader valve 3509 014 007 9



Cylinder Head With Plate Kit 3509 014 003 9



Repair Kit 3509 014 005 9



Crankshaft 3509 014 024 1



Flange With Bushing 3509 014 008 9



Repair Kit 3509 014 012 9

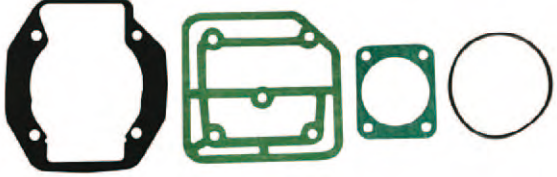

Piston And Rings 3509 005 005 9

Cross Ref.: Scania:1698848
Mercedes: 001 131 93 11





PARAMETER
Working Volume: 225cm³
Water Cooling, Max Speed: 3000 RPM
Stroke 37mm

SORL P/N
RL3509CH

Cross Ref.
8845035860, 9111550500

Application
VW 2T0100759



Connecting Rod 3509 058 005 8
Cross Ref.: WABCO: 911 145 737 2



Rings 3509 003 003 9
Cross Ref.: WABCO:911 501 920 2

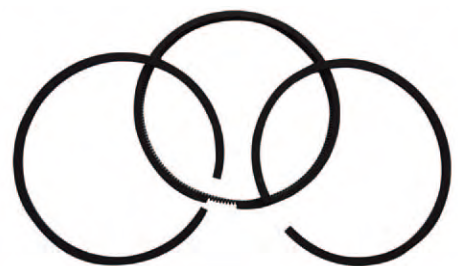

Crankshaft 3509 029 003 1



Piston And Rings 3509 003 004 9
Cross Ref.: WABCO: 911 501 624 2



Piston 3509 003 004 8



COMPRESSOR (SINGLE CYLINDER)



PARAMETER
Working Volume: 318cm³
Water Cooling, Max Speed: 3000 RPM
Stroke 56mm

SORL P/N
RL3509DH-B

Cross Ref.
9111530010

Application
MERCEDES 4571300515

Repair Kit 3509 056 003 9



Cylinder Head 3509 056 003 1
Cross Ref.: Mercedes: 000 131 21 21



back cover 3509 003 008 1
Cross Ref.: WABCO: 411 147 603 4



Connecting Rod 3509 058 005 8
Cross Ref.: WABCO: 911 145 737 2



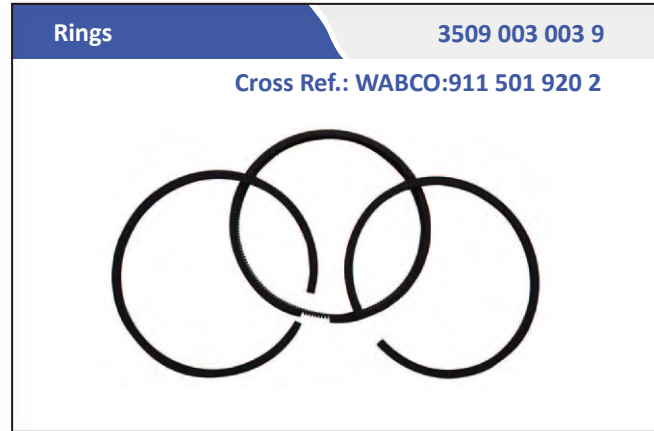

PARAMETER
Working Volume: 352cm³
Water Cooling, Max Speed: 3000 RPM
Stroke 62mm

SORL P/N
RL3509DH-C

Cross Ref.
4123520260

Application
Mercedes 4571304415

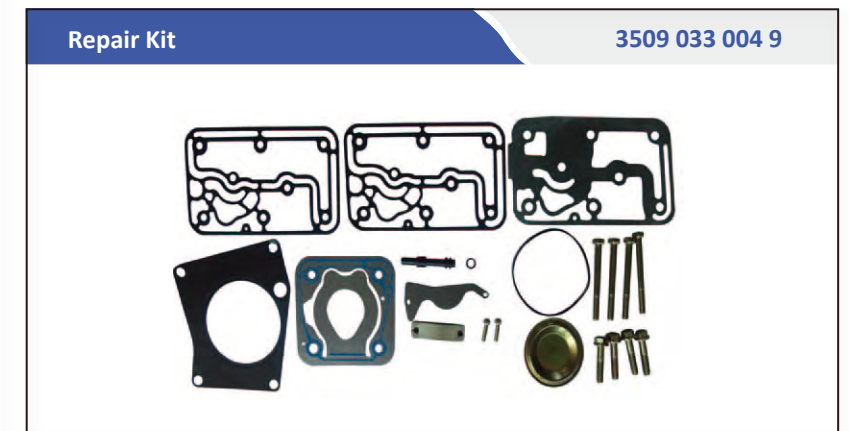

Bushing 3509 033 006 1

Connecting Rod 3509 033 001 8

Cross Ref.: WABCO: 911 145 738 2
Mercedes: 000 131 25 17

Repair Kit 3509 033 003 9

Cross Ref.: WABCO: 412 352 923 2
Mercedes: 001 130 10 15

Crankshaft

Cross Ref.: Mercedes: 000 131 76 16
3509 033 004 1

By Pass Valve 3509 033 005 9

Piston And Rings

Cross Ref.: WABCO: 911 501 624 2

3509 003 004 9

Back Cover 3509 003 008 1

Cross Ref.: WABCO: 411 147 603 4

Piston 3509 003 004 8

Rings 3509 003 003 9

Cross Ref.: WABCO: 911 501 920 2

COMPRESSOR (SINGLE CYLINDER)

PARAMETER
Working Volume: 359cm³
Water Cooling, Max Speed: 3000 RPM
Stroke 54mm

SORL P/N
RL3509DJ

Cross Ref.
K001119V

Application
Scania 1678516

Valve Plate Kit 3509 036 001 9

Cylinder Head With Plate Kit 3509 036 002 9

Repair Kit 3509 036 003 9

Cylinder Head 3509 036 002 1

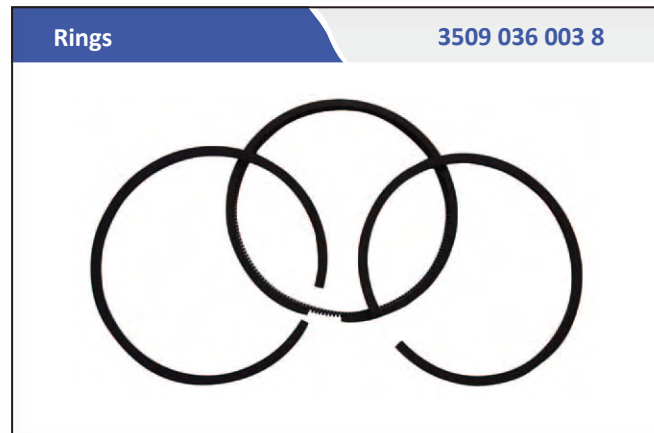
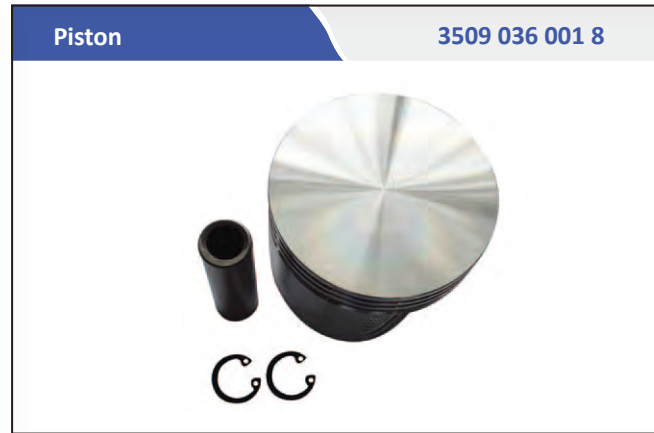

PARAMETER
Working Volume: 292cm³
Air Cooling, Max Speed: 3000 RPM
Stroke 46mm

SORL P/N
RL3509AE

Application
Mercedes 4701300115
MAN 51540007058



PARAMETER
Working Volume: 292cm³
Air Cooling, Max Speed: 3000 RPM
Stroke 46mm

SORL P/N
RL3509AE-A

Application
MAN 51540007074
Mercedes 4701301515

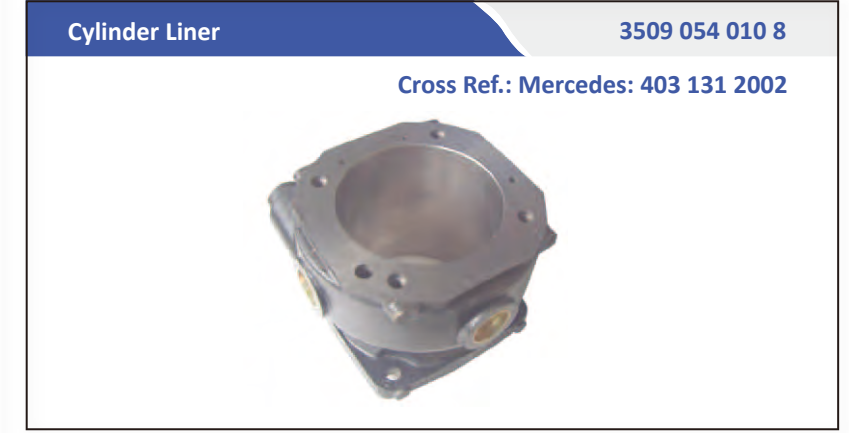

Flange With Bushing 3509 054 011 8

Cross Ref.: Mercedes: 403 130 1645
MAN:51 54130 6011



Cylinder Liner with Piston & Rings 3509 054 008 8

Cross Ref.: Mercedes: 442 130 00 08



Crankshaft 3509 054 015 1

Cross Ref.: Mercedes: 403 131 0216
MAN:51 54113 5017



Cylinder Liner with Piston & Rings 3509 054 009 8

Cross Ref.: Mercedes: 402 130 0608



Connecting Rod 3509 054 001 8

Cross Ref.: Mercedes: 403 130 2816
MAN:51 54106 6013



Piston And Rings 3509 054 003 8

Cross Ref.: Mercedes: 442 130 00 08



Cylinder Head 3509 054 004 8

Cross Ref.: Mercedes: 411 130 00 08



Piston 3509 054 007 8



Rings 3509 001 007 8



COMPRESSOR (SINGLE CYLINDER)



PARAMETER
Working Volume: 292cm³
Water Cooling, Max Speed: 3000 RPM
Stroke 46mm

SORL P/N
RL3509AZ-E

Cross Ref.
4751300115R

Application
MERCEDES A4271300515
A4751300115R

Valve Plate Kit 3509 055 001 9



Cylinder Head 3509 055 003 1

Cross Ref.: Mercedes: 407 130 05 19



Cylinder Head With Plate Kit 3509 055 006 9



Valve Plate 3509 055 002 8



Repair Kit 3509 055 003 9

Cylinder Head With Plate Kit 3509 055 010 9

Valve Plate Kit 3509 055 014 9

Piston 3509 054 007 8

Crankshaft 3509 054 015 1

Cross Ref.: Mercedes: 403 131 0216
MAN:51 54113 5017

Valve Plate Kit 3509 055 011 9

Repair Kit 3509 055 015 9

Cross Ref.: Mercedes: 442 130 00 20

Rings 3509 001 007 8

Connecting Rod 3509 054 001 8

Cross Ref.: Mercedes: 403 130 2816
MAN:51 54106 6013

Valve Plate Kit 3509 055 012 9

Cylinder Liner with Piston & Rings 3509 055 005 9

Cross Ref.: Mercedes: 442 130 00 08
MAN:51 54160 6006

Flange With Bushing 3509 055 004 9

Cross Ref.: Mercedes: 403 130 1645
MAN:51 54130 6011

Repair Kit 3509 055 013 9

Cross Ref.: Mercedes: 442 130 00 20

Piston And Rings 3509 054 003 8

Cross Ref.: Mercedes: 442 130 00 08

COMPRESSOR (SINGLE CYLINDER)



PARAMETER
Working Volume: 225cm³
Water Cooling, Max Speed: 3000 RPM
Stroke 37mm

SORL P/N
RL3509BX

Cross Ref.
8845034370

Application
Mercedes A9061300615

Repair Kit 3509 056 001 9



Repair Kit 3509 056 003 9



Cylinder Head 3509 056 003 1

Cross Ref.: Mercedes: 000 131 21 21



back cover 3509 003 008 1

Cross Ref.: WABCO: 411 147 603 4



Valve Plate 3509 056 002 9

Cross Ref.: Mercedes: 411 151 65 22



Bushing 3509 056 006 1



Connecting Rod 3509 033 001 8

Cross Ref.: WABCO: 911 145 738 2
Mercedes: 000 131 25 17



Crankshaft 3509 056 002 1



Repair Kit 3509 056 012 9



Piston And Rings 3509 003 004 9

Cross Ref.: WABCO: 911 501 624 2



Piston 3509 003 004 8



Rings 3509 003 003 9

Cross Ref.: WABCO: 911 501 920 2

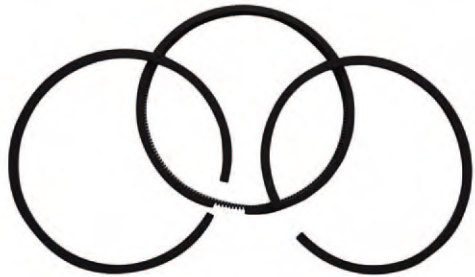



PARAMETER
Working Volume: 636cm³
Water Cooling, Max Speed: 3000 RPM
Stroke 56mm

SORL P/N
RL3509BC

Cross Ref.
9115530020

Application
Mercedes 4571301815

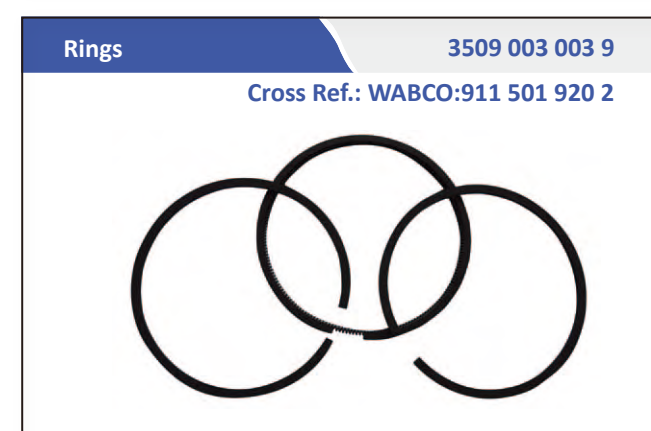

COMPRESSOR (TWIN CYLINDERS)



PARAMETER
Working Volume: 600cm³
Water Cooling, Max Speed: 3000 RPM
Stroke 56mm

SORL P/N
RL3509BH

Cross Ref.
ACX83D

Application
IVECO 500310903
500314094

Cylinder Head With Plate Kit 3509 028 001 9

Cross Ref.: KNORR:K01920
IVECO:93162116 93161842



Cylinder Head 3509 028 004 1



Valve Plate 3509 028 002 9



Gasket Kit 3509 028 004 9



back cover 3509 028 005 1

Cross Ref.: KNORR:II159920065
IVECO:1376275 1376285



Repair Kit 3509 028 003 9



Connecting Rod 3509 028 001 8

Cross Ref.: KNORR:SEB 00967004
IVECO:3097151



Bushing 3509 028 012 1



Rings 3509 028 003 8



Crankshaft 3509 028 002 1

Cross Ref.: IVECO:1137760



back cover 3509 028 011 9



Piston And Rings 3509 028 005 9



Piston 3509 028 002 8





PARAMETER
Working Volume: 363cm³
Water Cooling, Max Speed: 3000 RPM
Stroke 47.5mm

SORL P/N
RL3509DH-A

Cross Ref.
RCCS00031

Application
SCANIA 1678516

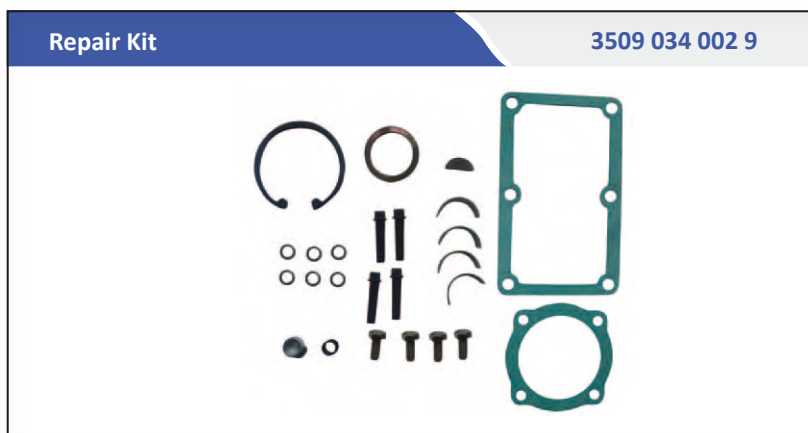
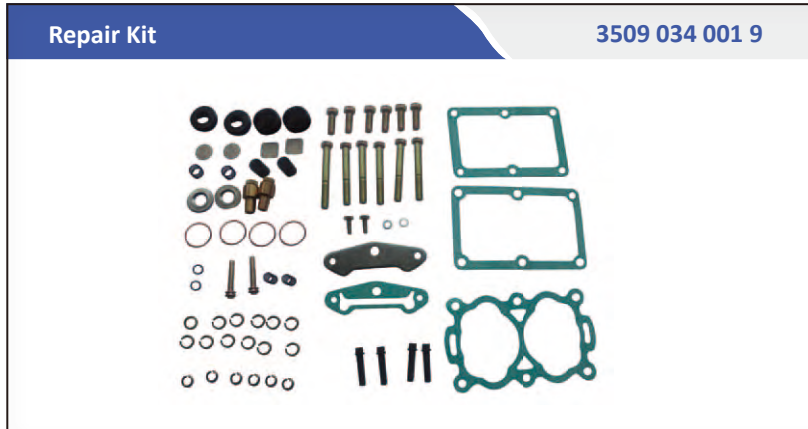

COMPRESSOR (TWIN CYLINDER)



PARAMETER
Working Volume: 636cm³
Water Cooling, Max Speed: 3000 RPM
Stroke 56mm

SORL P/N
RL3509DH-E

Cross Ref.
9125101040

Application
MERCEDES 4571304915

Cylinder Head With Plate Kit 3509 035 002 9

Cross Ref.: WABCO:912 510 920 2
Mercedes: 001 130 59 19



Repair Kit 3509 035 003 9



Valve Plate 3509 035 001 9



Cylinder Head 3509 035 002 1



Crankshaft 3509 035 004 1

Cross Ref.: WABCO:412 636 690 4
Mercedes: 000 131 7216



Connecting Rod 3509 033 001 8

Cross Ref.: WABCO: 911 145 738 2
Mercedes: 000 131 25 17



Bushing 3509 033 006 1



By Pass Valve 3509 035 004 9



Back Cover 3509 003 008 1

Cross Ref.: WABCO: 411 147 603 4



Piston And Rings 3509 003 004 9

Cross Ref.: WABCO: 911 501 624 2



Piston 3509 003 004 8



Rings 3509 003 003 9

Cross Ref.: WABCO:911 501 920 2

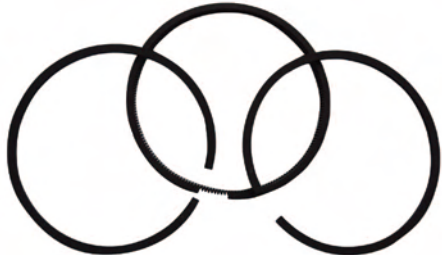

COMPRESSOR (TWIN CYLINDER)



PARAMETER
Working Volume: 627cm³
Water Cooling, Max Speed: 3000 RPM
Stroke 54mm

SORL P/N
RL3509DJ-A

Cross Ref.
LK4936

Application
IVECO 42534245
42534247

Cylinder Head With Plate Kit 3509 037 001 9



Cylinder Head 3509 037 002 1



Valve Plate Kit 3509 037 002 9



Repair Kit 3509 037 003 9



Valve Plate 3509 037 005 8



Connecting Rod 3509 037 002 8



Back Cover 3509 037 003 1



Crankshaft 3509 037 004 1



Piston And Rings 3509 037 004 9
Cross Ref.: IVECO:42549147



Piston 3509 037 001 8



Rings 3509 037 003 8



COMPRESSOR (TWIN CYLINDER)



PARAMETER
Working Volume: 608cm³
Water Cooling, Max Speed: 3000 RPM
Stroke 50mm

SORL P/N
RL3509DH-A

Cross Ref.
LK4941

Application
SCANIA 1796663

Cylinder Head With Plate Kit 3509 031 001 9



Cylinder Head 3509 031 002 1
Cross Ref.: SCANIA:1424766



Valve Plate Kit 3509 031 002 9
Cross Ref.: SCANIA:1376272



Repair Kit 3509 031 003 9



Gasket Kit 3509 031 004 9



By Pass Valve 3509 035 004 9



back cover 3509 031 003 1
Cross Ref.: SCANIA:1932013



Connecting Rod 3509 031 002 8
Cross Ref.: SCANIA:3097151



Crankshaft 3509 031 004 1



Piston And Rings 3509 005 005 9
Cross Ref.: SCANIA:1698848
Mercedes: 001 131 93 11



Piston 3509 005 003 8



Rings 3509 005 004 8
Cross Ref.: Mercedes: 001 131 06 11



COMPRESSOR (TWIN CYLINDER)



PARAMETER
Working Volume: 440cm³
Water Cooling, Max Speed: 3000 RPM
Stroke 50mm

SORL P/N
RL3509DH

Cross Ref.
II35564, LP4850

Application
VOLVO 8119270
8129779
8113270

Cylinder Head With Plate Kit 3509 030 001 9



Cylinder Head 3509 030 002 1
Cross Ref.: VOLVO: 1283815



Repair Kit 3509 030 003 9

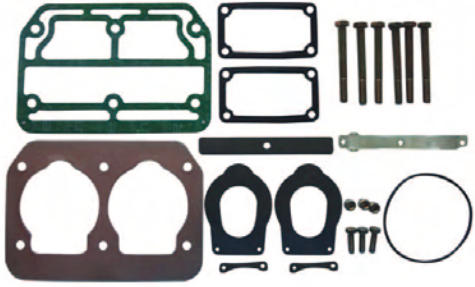

Valve Plate Kit 3509 030 002 9



Gasket Kit 3509 030 005 9
Cross Ref.: KNORR: II326840061



Crankshaft 3509 030 004 1
Cross Ref.: VOLVO: 1315290



Connecting Rod 3509 030 003 8
Cross Ref.: VOLVO: 1315278



Back Cover 3509 030 003 1
Cross Ref.: VOLVO: 1315292



Bushing 3509 030 012 1
Cross Ref.: VOLVO:1315274
WABCO:411 522 340 4



Piston And Rings 3509 030 004 9
Cross Ref.: Mercedes: 001 131 16 07
VOLVO: 1315297



Piston 3509 030 001 8



Rings 3509 030 005 8
Cross Ref.: Mercedes: 000 131 67 11



COMPRESSOR (TWIN CYLINDER)



PARAMETER
Working Volume: 442cm³
Water Cooling, Max Speed: 3000 RPM
Stroke 50mm

SORL P/N
RL3509BE

Cross Ref.
KZ433.1, KZ642.1

Application
VOLVO 8112781
SCANIA 571181

Cylinder Head 3509 051 002 1

Cross Ref.: VOLVO: 3090472
SCANIA:1518374



Valve Plate 3509 051 003 1

Cross Ref.: VOLVO: 3090473
SCANIA:1518372



Repair Kit 3509 051 003 9



Cylinder Head With Plate Kit 3509 051 010 9



Repair Kit 3509 051 011 9

Cross Ref.:SCANIA: 1327886
KNORR: I1810150061



Connecting Rod 3509 051 001 8

Cross Ref.: SCANIA:1518356, 1322814
VOLVO:3090257



Crankshaft 3509 051 005 1

Cross Ref.: SCANIA:1518353



Repair Kit 3509 051 004 9



Flange With Bushing 3509 051 005 9

Cross Ref.: SCANIA:1518349, 16962001
VOLVO:3090239



Piston And Rings 3509 051 001 9



Piston 3509 051 003 8

Cross Ref.: VOLVO:3094151



Rings 3509 051 004 8

Cross Ref.: VOLVO:3094155



COMPRESSOR (TWIN CYLINDER)



PARAMETER
Working Volume: 292cm³
Water Cooling, Max Speed: 3000 RPM
Stroke 38.1mm

SORL P/N
RL3509BX-A

Cross Ref.
EL13151

Application
CATERPILLAR

Repair Kit 3509 057 001 9



Cylinder Head 3509 057 003 1



Cylinder Liner 3509 057 002 1



Crankshaft 3509 057 004 1



Connecting Rod 3509 057 003 8



Piston And Rings 509 057 002 9



Piston 3509 057 001 8



Rings 3509 057 002 8



Cylinder Liner with Piston & Rings 3509 100 021 9
Cross Ref.: Mercedes: 004 26 90



Valve Plate Kit 3509 100 025 9
Cross Ref.: Mercedes: 541 130 0820



Cylinder Head 3509 100 029 9

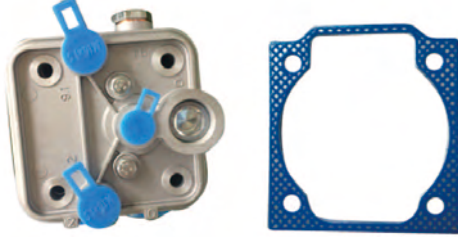

Valve Plate Kit 3509 100 022 9
Cross Ref.: Mercedes: 541 130 0520



Cylinder Head 3509 100 026 9



Valve Plate Kit 3509 100 023 9
Cross Ref.: Mercedes: 442 130 0220



Cylinder Head 3509 100 027 9

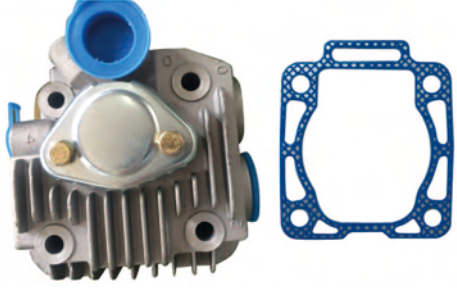

Valve Plate Kit 3509 100 024 9
Cross Ref.: MAN:F2000



Cylinder Head 3509 100 028 9

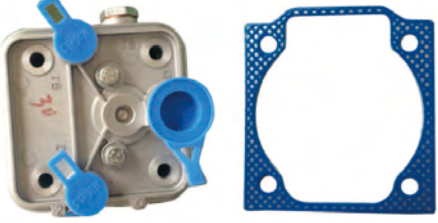

Compressor (Single Cylinder) RL3509BB-A

Cross Ref.: BENDIX 109267N
Application: Caterpillar 3306/3306B



Working Volume: 215cm³
Water Cooling: Max Speed: 3000RPM
Stroke: 37.2mm

Compressor (Twin Cylinder) RL3509BD-A

Cross Ref.: EL740
Application: Caterpillar



Working Volume: 168cm³
Water Cooling: Max Speed: 3000RPM
Stroke: 41.4mm

Compressor (Twin Cylinder) RL3509DF-A

Cross Ref.: bendix tf400 102655
Application: Caterpillar



Working Volume: 164cm³
Water Cooling: Max Speed: 3000RPM
Stroke: 38.1mm

Compressor (Twin Cylinder) RL3509BN01

Cross Ref.: LP4985
Application: Volvo FH12/FH16/FM



Working Volume: 608cm³
Water Cooling: Max Speed: 3000RPM
Stroke: 50mm

Compressor (Single Cylinder) RL3509DJ-C

Cross Ref.: 1059/3X



Working Volume: 144cm³
Water Cooling: Max Speed: 3000RPM
Stroke: 41.4mm

Compressor (Twin Cylinder) RL3509DE-A

Cross Ref.: Bendix tf550 5001523
Application: Caterpillar



Working Volume: 297cm³
Water Cooling: Max Speed: 3000RPM
Stroke: 38mm

Compressor (Twin Cylinder) RL3509DJ-F

Cross Ref.: 911 504 506 0
Application: DAF



Working Volume: 442cm³
Water Cooling: Max Speed: 3000RPM
Stroke: 50mm

Compressor (Twin Cylinder) RL3509BM01

Cross Ref.: LK4951
Application: Scania Euro4 G420/G440/R440



Working Volume: 720cm³
Water Cooling: Max Speed: 3000RPM
Stroke: 62mm

Compressor (Single Cylinder) RL3509BA02

Cross Ref.: 53205-3509015-02
Application: Kamaz



Working Volume: 306cm³
Water Cooling: Max Speed: 3000RPM
Stroke: 46mm

Compressor (Twin Cylinder) RL3509DE-B

Cross Ref.: Bendix tf550 108986
Application: Caterpillar



Working Volume: 297cm³
Water Cooling: Max Speed: 3000RPM
Stroke: 38mm

Compressor (Twin Cylinder) RL3509BF01

Cross Ref.: 912 512 008 0
Application: Renault 430/440
Volvo FH16



Working Volume: 636cm³
Water Cooling: Max Speed: 3000RPM
Stroke: 56mm

Compressor (Twin Cylinder) RL3509BA01

Cross Ref.: 5320-3509015
Application: Kamaz



Working Volume: 215cm³
Water Cooling: Max Speed: 3000RPM
Stroke: 38mm

Compressor (Single Cylinder) RL3509AN

Cross Ref.: I90265
Application: VW TAC145605



Working Volume: 225cm³
Water Cooling, Max Speed: 3000 RPM
Stroke 37mm

Compressor (Twin Cylinder) RL3509AN-D

Cross Ref.: K001330
Application: VW 2R0100759H
Volvo 20742000



Working Volume: 225cm³
Water Cooling, Max Speed: 3000 RPM
Stroke 37mm

Compressor (Twin Cylinder) RL3509DJ-E

Cross Ref.: 612600130496
Application: Caiwei WP6



Working Volume: 168cm³
Water Cooling, Max Speed: 3000 RPM
Stroke 38mm

Compressor (Twin Cylinder) RL3509BJ

Cross Ref.: 9115040520
Application: DAF 762788



Working Volume: 440cm³
Water Cooling, Max Speed: 2800 RPM
Stroke 50mm

Compressor (Single Cylinder) RL3509AN-B

Cross Ref.: II31343
Application: VW 2VC145605



Working Volume: 225cm³
Water Cooling, Max Speed: 3000 RPM
Stroke 37mm

Compressor (Twin Cylinder) RL3509AB01

Cross Ref.: 3509010-B4000
Application: Yutong Bus B4000



Working Volume: 293cm³
Water Cooling, Max Speed: 3000 RPM
Stroke 46mm

Compressor (Twin Cylinder) RL3509CD

Cross Ref.: II15140, 4110345310
Application: Mercedes A0021313701
A0021311501



Working Volume: 225cm³
Water Cooling, Max Speed: 3000 RPM
Stroke 37mm

Compressor (Twin Cylinder) RL3509BZ-H

Cross Ref.: VG1560130080
Application: SINO Truck



Working Volume: 636cm³
Water Cooling, Max Speed: 1250 RPM
Stroke 56mm

Compressor (Single Cylinder) RL3509CA02

Cross Ref.: 3509010-671-0382
Application: FAW CA6DL



Working Volume: 293cm³
Water Cooling, Max Speed: 3000 RPM
Stroke 46mm

Compressor (Twin Cylinder) RL3509DJ-D

Cross Ref.: 612600130307
Application: Caiwei WP10



Working Volume: 293cm³
Water Cooling, Max Speed: 3000 RPM
Stroke 46mm

Compressor (Twin Cylinder) RL3509CE

Cross Ref.: II36928AGR
Application: Mercedes



Working Volume: 225cm³
Water Cooling, Max Speed: 3000 RPM
Stroke 37mm

Compressor (Twin Cylinder) RL3509EA

Application: FAW, More Than 10m Vehicle



Working Volume: 440cm³
Air Cooling, Max Speed: 1420 RPM
Stroke 50mm, DC: (220-380)V

**Compressor
(Single Cylinder)**

RL3509EB

**Cross Ref.: SPWOED 3224
Application: Bus**



**Working Volume:32L/Min
DC: 24V, Air Cooling
Max working pressure: 0.7MPa**